



制作前请仔细阅读以下内容
READ CAREFULLY BEFORE START

1. 使用粘接剂前请务必进行各零件间的假组合;
2. 金属零件可能有轻微变形现象, 使用前请小心进行矫正, 用力过度或操作不当会导致零件损毁;
3. 可以使用热矫正的方法 (如吹风机) 处理树脂零件变形的情况, 但请务必小心操作以避免零件损坏;
4. 某些零件使用前需要进行水口切除等修整操作;
5. 去除所有零件上的分模线及水口后, 请在开始上色前使用专用的水补土喷涂打底;
6. 请使用中性洗涤剂清洗全部树脂零件以增强油漆附着力和上色效果;
7. 请使用快干胶水及环氧树脂 (AB胶水) 来组合粘接各零件(请另行购买);
8. 水贴纸及金属贴纸请于阴凉干燥处进行保存, 切勿弯折;
9. 当心窒息危险及锋利零件, 请务必将零件及零件保存在孩童触及不到的地方。

1. Please try test fit carefully between every parts before applying adhesives.
2. Metal parts may be slightly out of shape when first taken out of the box. You can restore the shape by carefully bending the part, but take caution as overexerting the part will cause it to damage.
3. You can change the shape of resin parts by applying heat (eg.using a hair dryer). But please be careful of damaging the parts.
4. Please be ware that some parts may have to be altered by cutting before the can be fit together.
5. After the parting lines and gates have been removed from all parts, please apply under coating (eg. primer surfacer) before painting.
6. Please clean all resin parts (eg. applying neutral detergent) before color painting.
7. Please use super glue or epoxy resin when building this kit.
8. Please carefully keep decals and metal stickers in dry and cool condition, avoid exposure to direct sunlight and do not bend.
9. Choking hazard and sharp parts warning! Please keep this kit and parts away from reach of children.



水贴使用说明
HOW TO APPLY DECALS

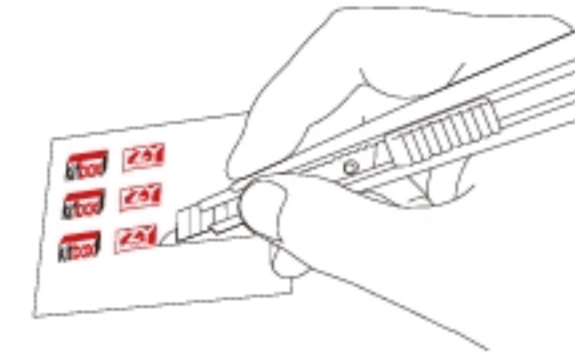

1. 请沿着贴纸外轮廓, 用剪刀或者笔刀小心裁切
Cut out the decal into the desired shape by scissors and cutter.

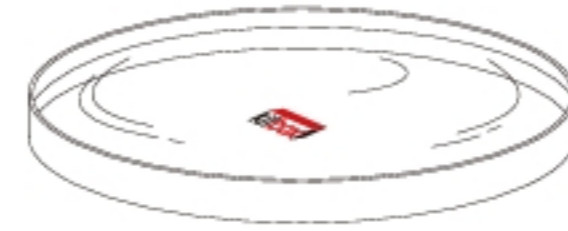

2. 请将贴纸用水浸湿10~30秒左右
Dip the decal into water for 10 to 30 seconds.

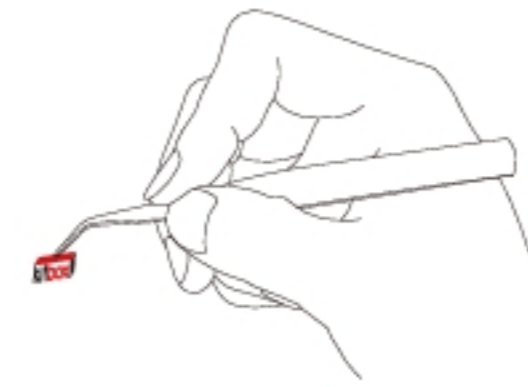

3. 请将贴纸置于准备粘贴的位置, 用镊子将图案从衬纸上小心剥离, 一边调整其位置, 一边用软布将多余水分擦拭掉
Put the decal on desired place and slide it gently from its backing sheet by tweezers. Adjust the decal position and dry excess water with a soft cloth.

零件清单/Parts List

开始制作前请根据清单清点零件以确认套件是否完整
Please check the kit content according to the following PARTS LIST before start.

树脂零件/Resin Parts

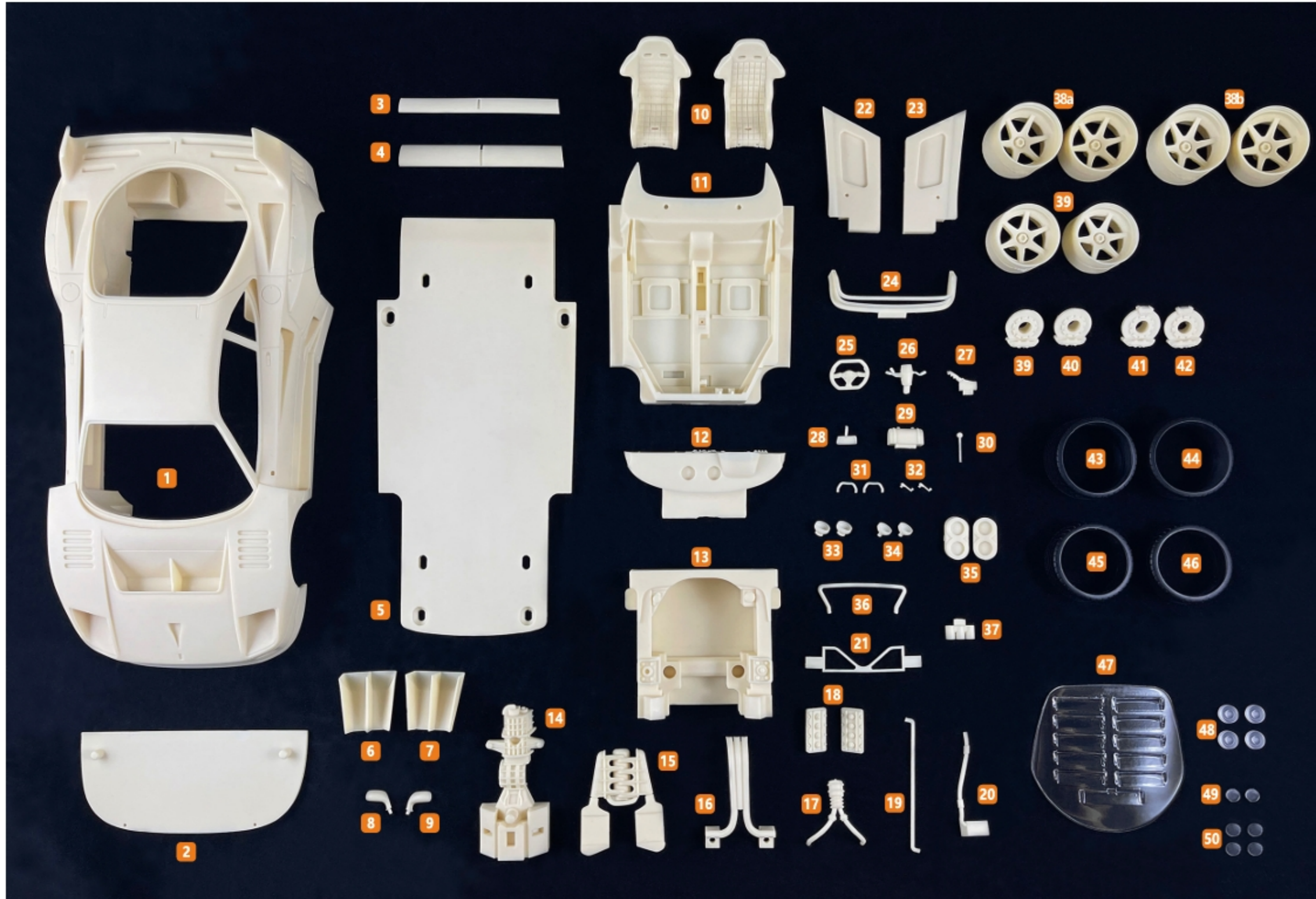

零件清单/Parts List

开始制作前请根据零件清单清点确认套件是否完整
Please confirm the kit content according to the following PARTS LIST before start.

蚀刻零件/PE Parts

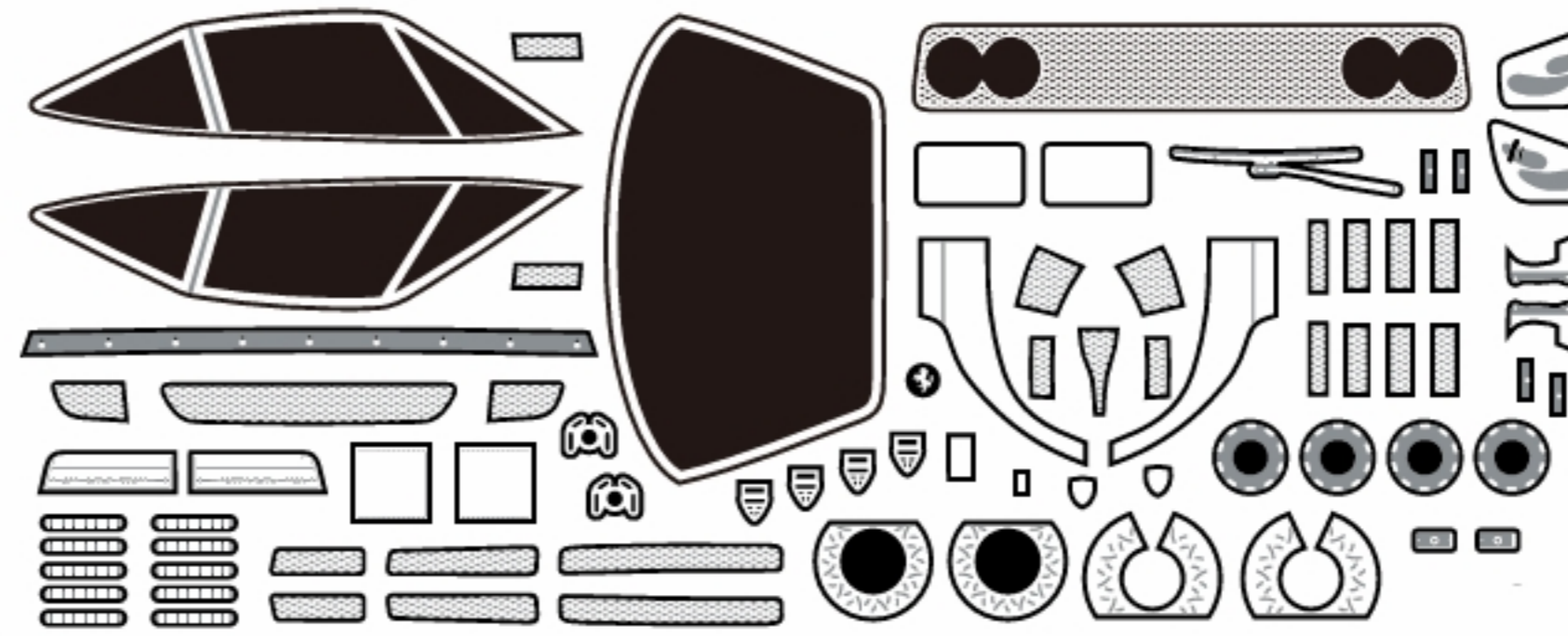

预裁切窗片/Pre-cut Window Sheets

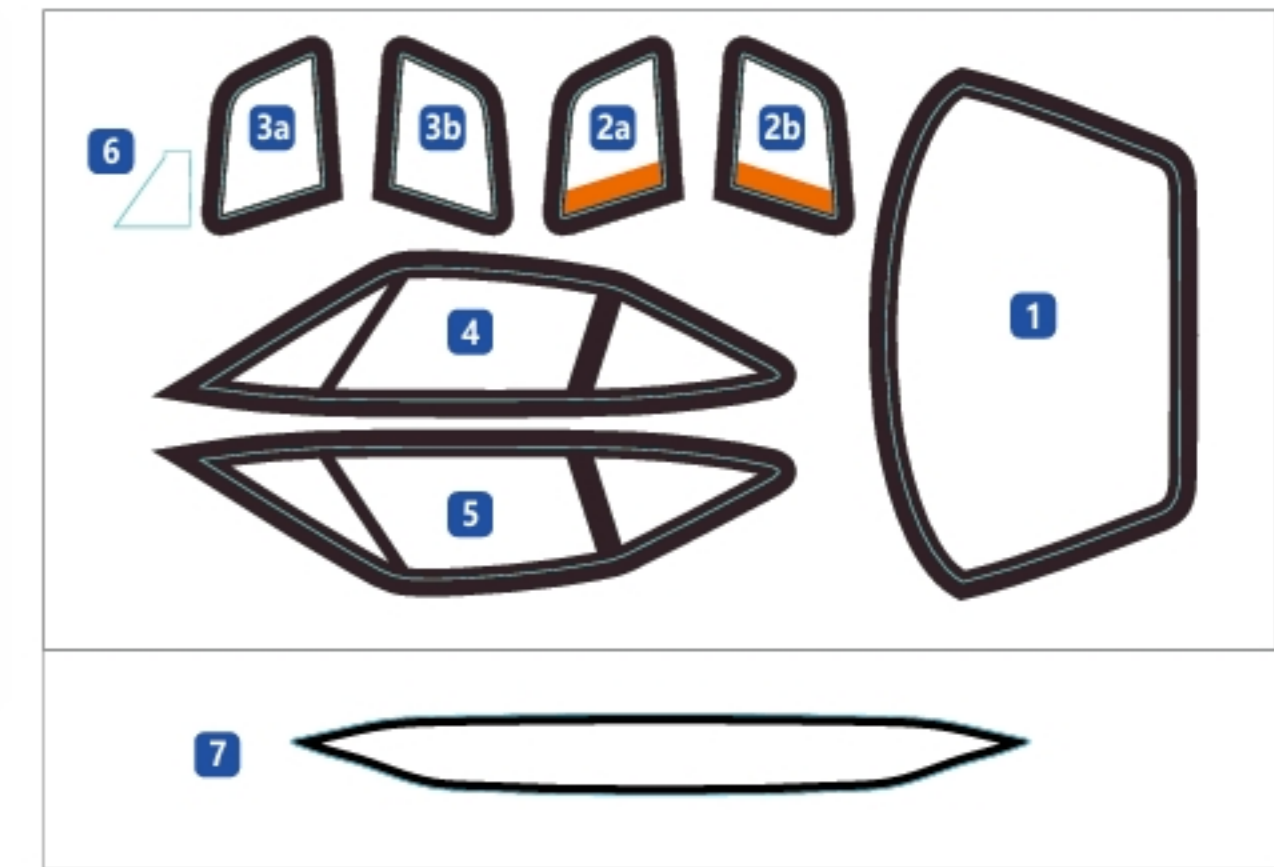

水贴 & 金属水贴/Decals & Metal Stickers

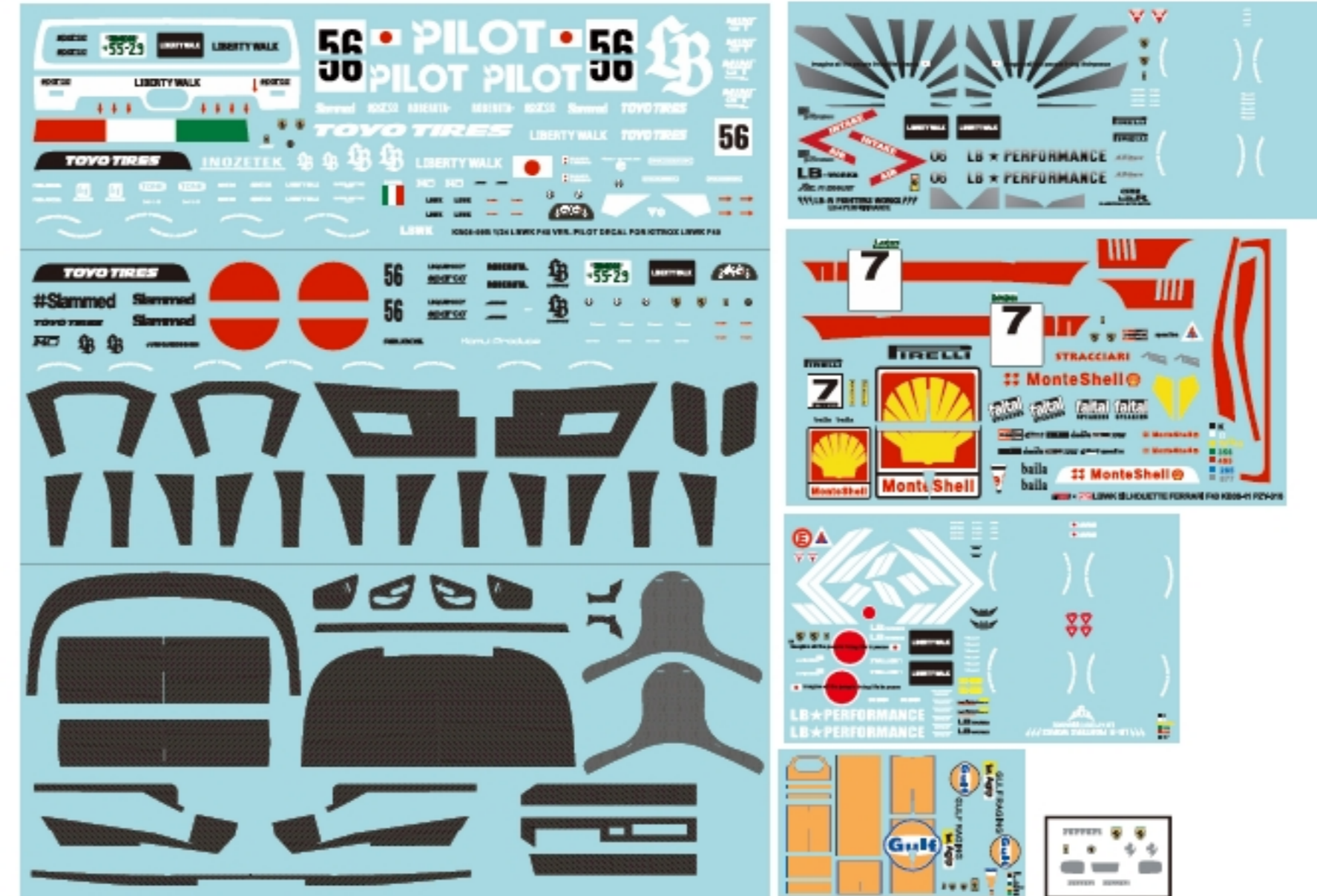

金属零件及其它/Metal Parts & Others

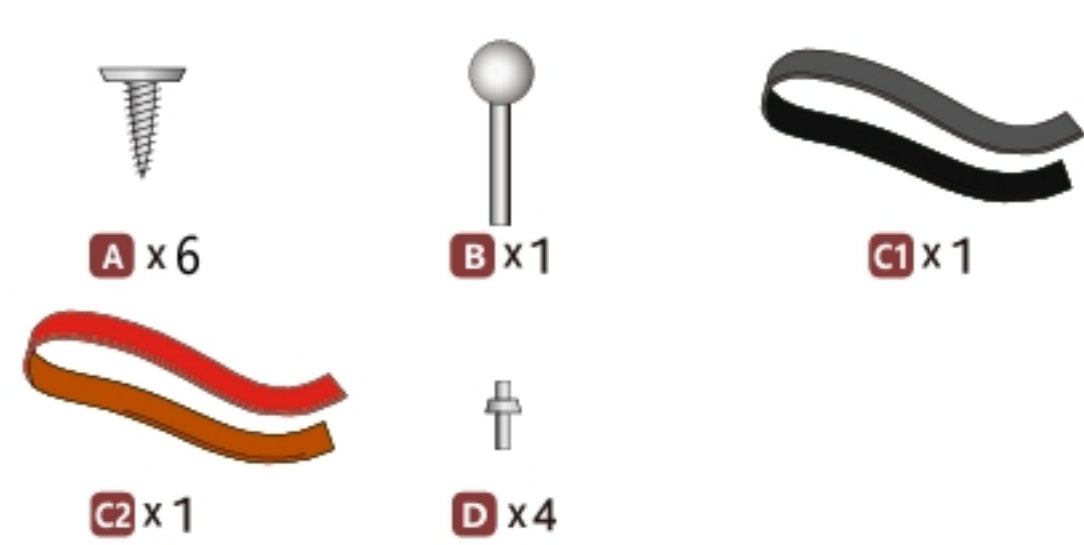

3D打印零件/3D Printed Parts



图例说明/Symbols Explanation



涂装说明/Painting Instructions

- ◆ 推荐使用TAMIYA (田宫) 及 GUNZE SANGYO (GSI CREOS, 郡士) 出品的水性或硝基系列模型专用涂料;
- ◆ 请勿将水性涂料 (Acrylic Paint) 与油性硝基涂料 (Lacquer Paint) 混合使用;
- ◆ 请另行购买所需涂料及上色喷涂工具, 具体使用方法请参考各产品说明书;
- ◆ 车体及内饰涂装请根据实车资料及个人喜好进行搭配。

- ◆ The acrylic paint & lacquer paint series from TAMIYA & GUNZE SANGYO (GSI CREOS) are highly recommended.
- ◆ Please don't mix ACRYLIC PAINT with LACQUER PAINT.
- ◆ Please purchase the paints and tools separately. For the use of them in details, please refer to the instructions of each products.
- ◆ Please decide the exterior and interior colors according to photos of the real car or your personal preference.

开始之前/Before Your Start

1 选择要制作的涂装/Choose and decide your favorite livery

选定涂装后，根据涂装说明页进行后续上色及水贴作业。
Please refer to the MARKINGS pages for proceeding the coloring and decal works.

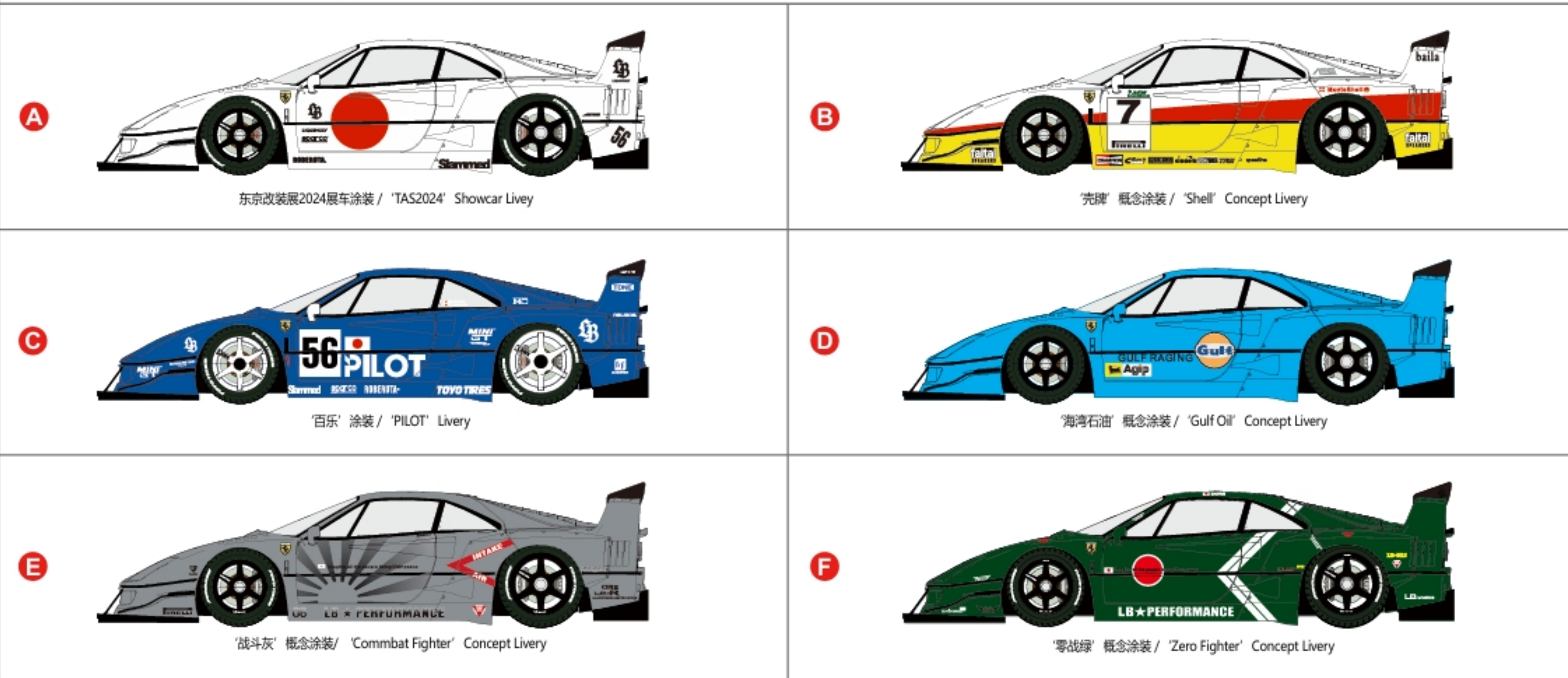

组装说明/Assembly Instruction

1 引擎舱零件组装/Engine Bay Parts Assembly

注意两侧卡榫方向
Pay attention to the direction of the tenons on both sides

粘接零件前请仔细进行假组合
Please test fitting parts before applying adhesive.

- 表示树脂零件标号
Number marks for resin parts
- 表示蚀刻零件标号
Number marks for PE parts
- 表示水贴及金属水贴标号
Number marks for decals & metal stickers
- 表示金属及其它零件标号
Number marks for metal & other parts
- 表示预裁切窗片标号
Number marks for pre-cut window sheets

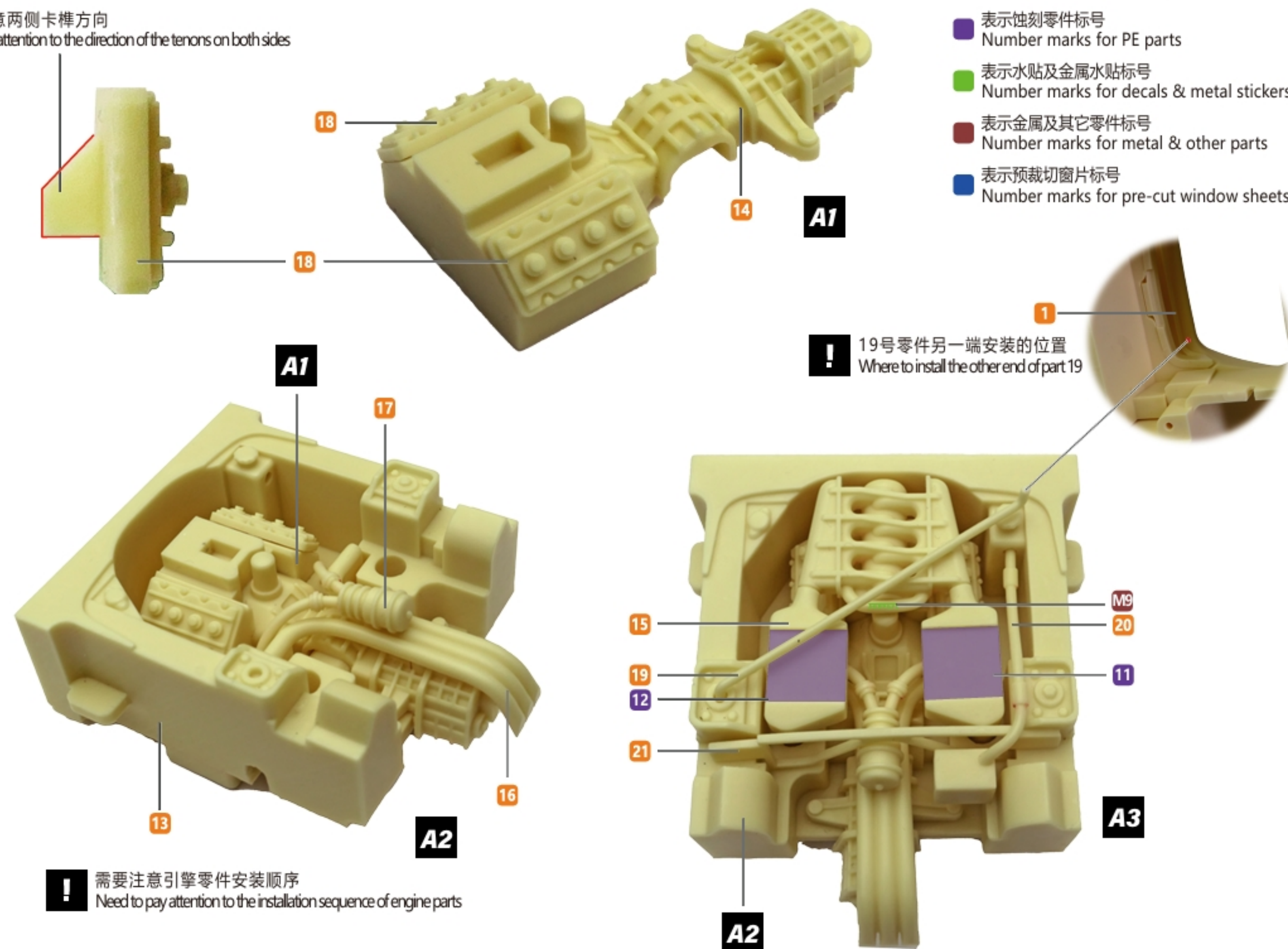

组装说明/Assembly Instruction

粘接零件前请仔细进行假组合
Please test fitting parts before applying adhesive.

2 内饰零件组装/Interior Parts Assembly

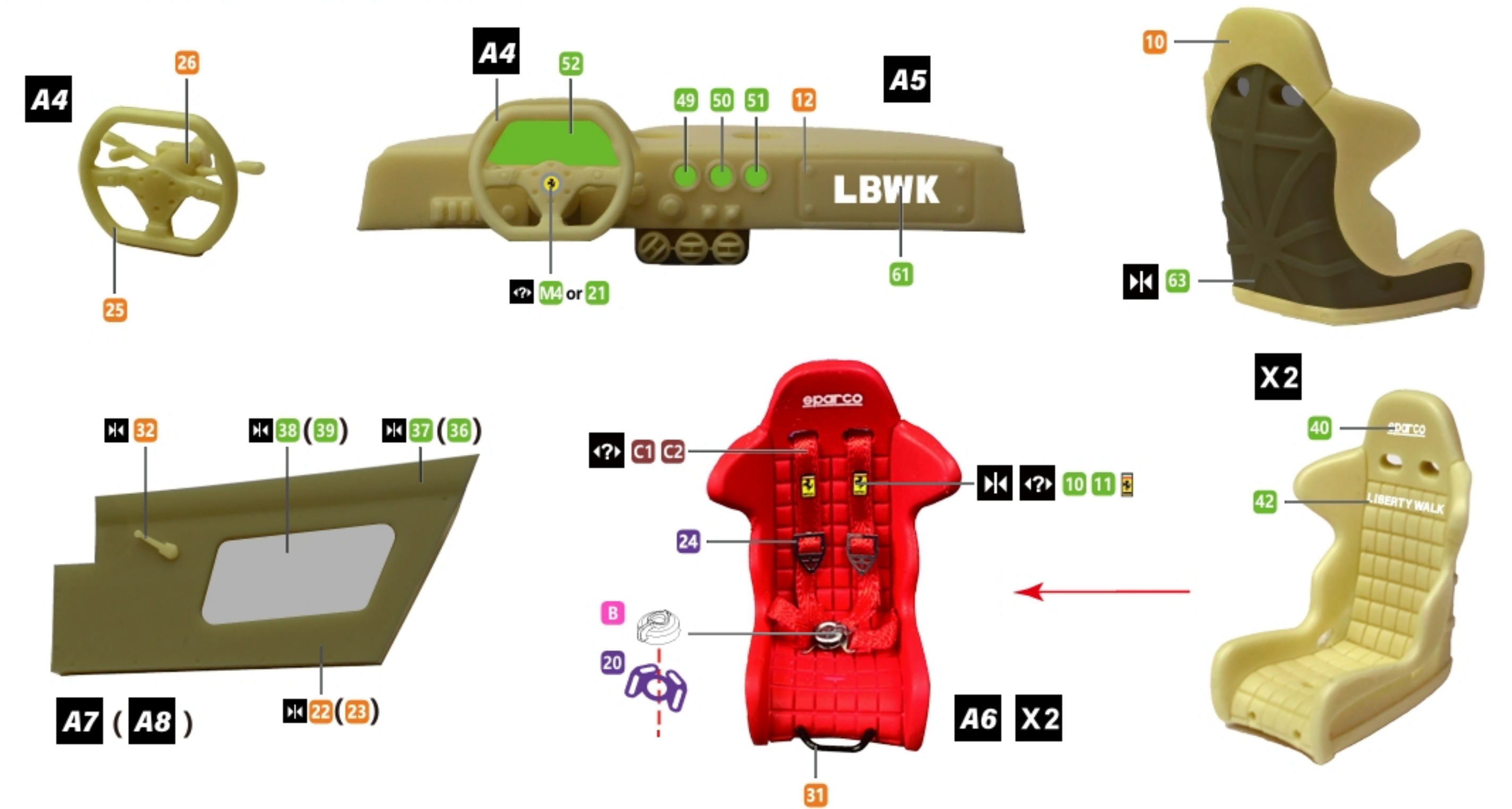

3 内饰零件组装/Interior Parts Assembly

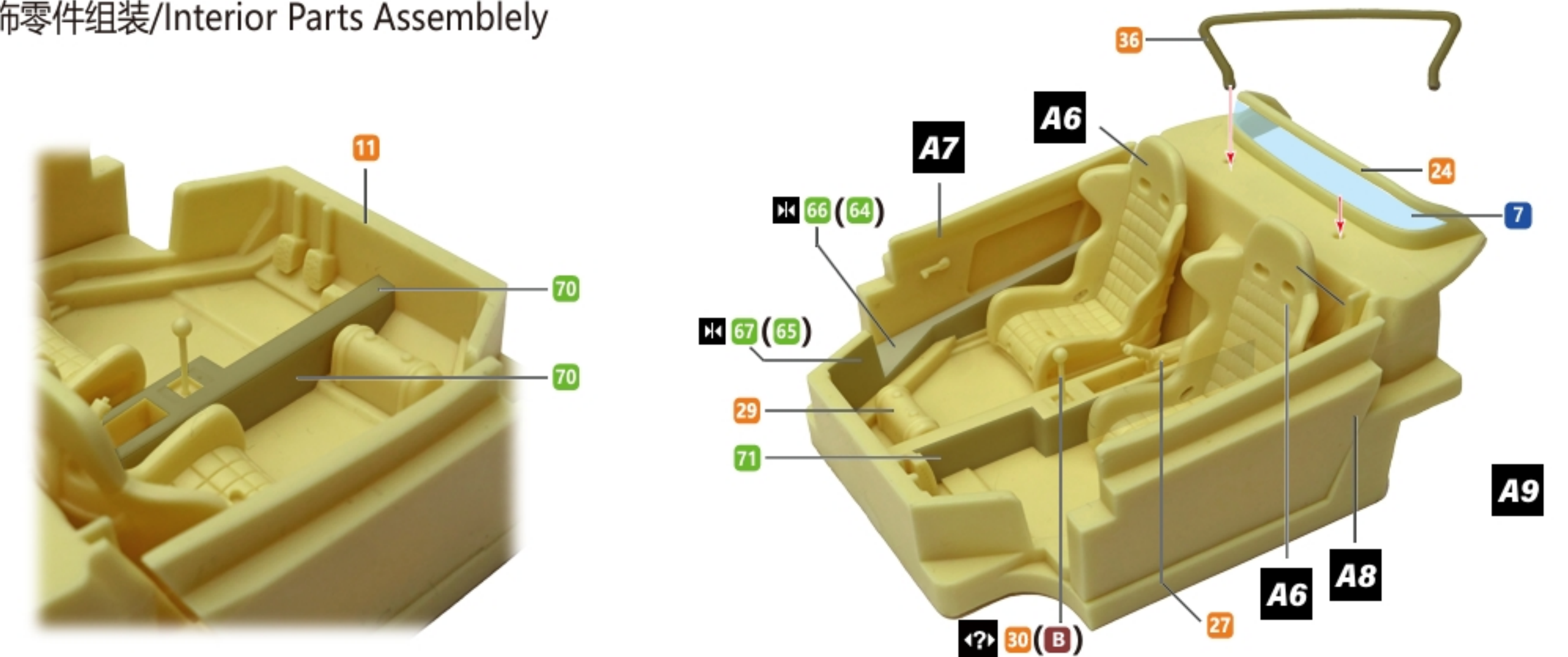

4 内饰零件组装/Interior Parts Assembly

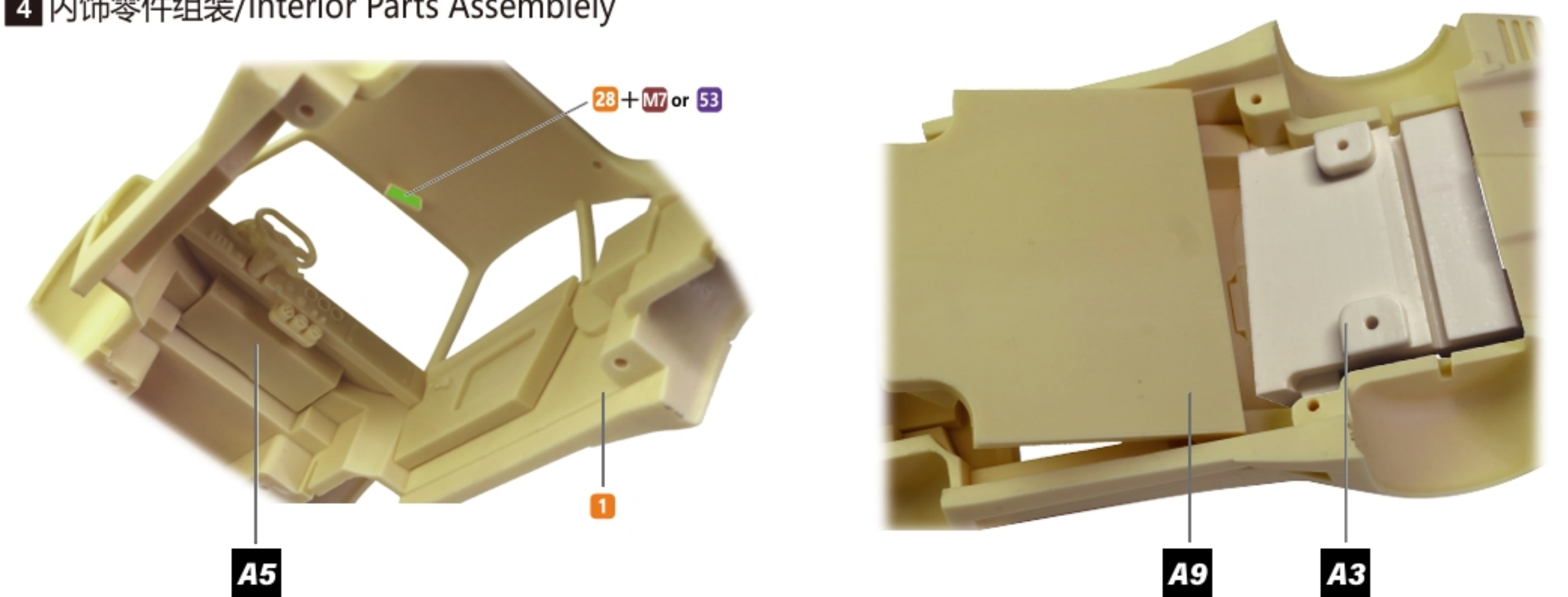

内饰请先安装中控台 "A5"
For the interior, please install the center console "A5" first.

安装 "A9" 零件时，先嵌入内饰的后半部分
When installing "A9" parts, embed the rear half of the interior first

组装说明/Assembly Instruction

2 底盘零件组装/Chassis Parts Assembly

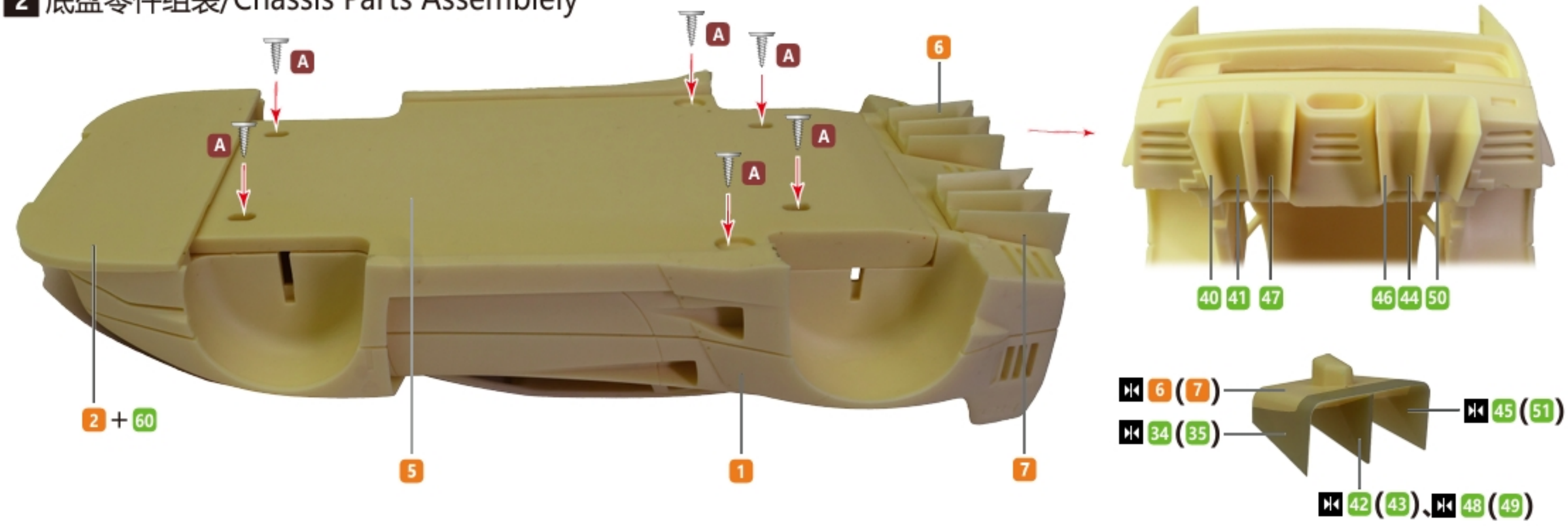

3 车轮及车体零件组装/Wheels & Body Parts Assembly

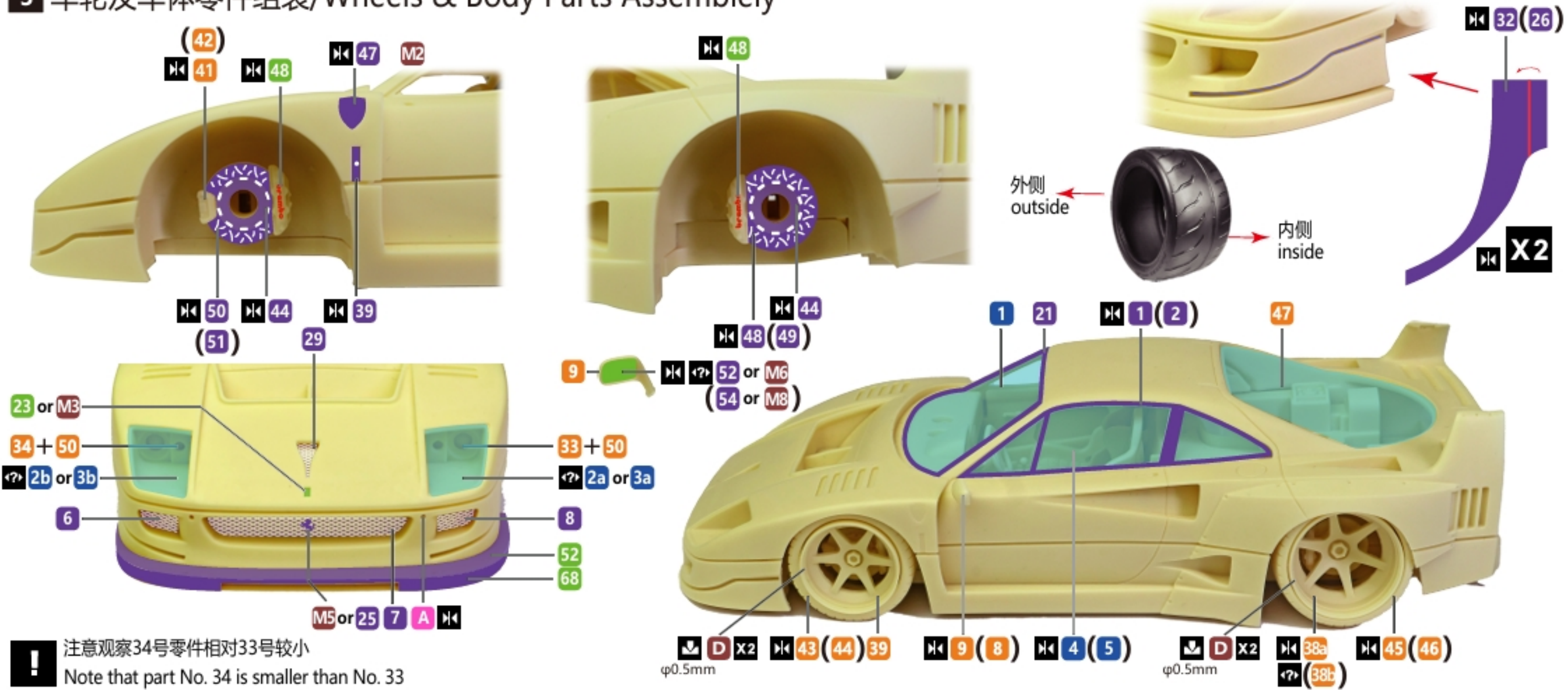

4 车体零件组装/Body Parts Assembly

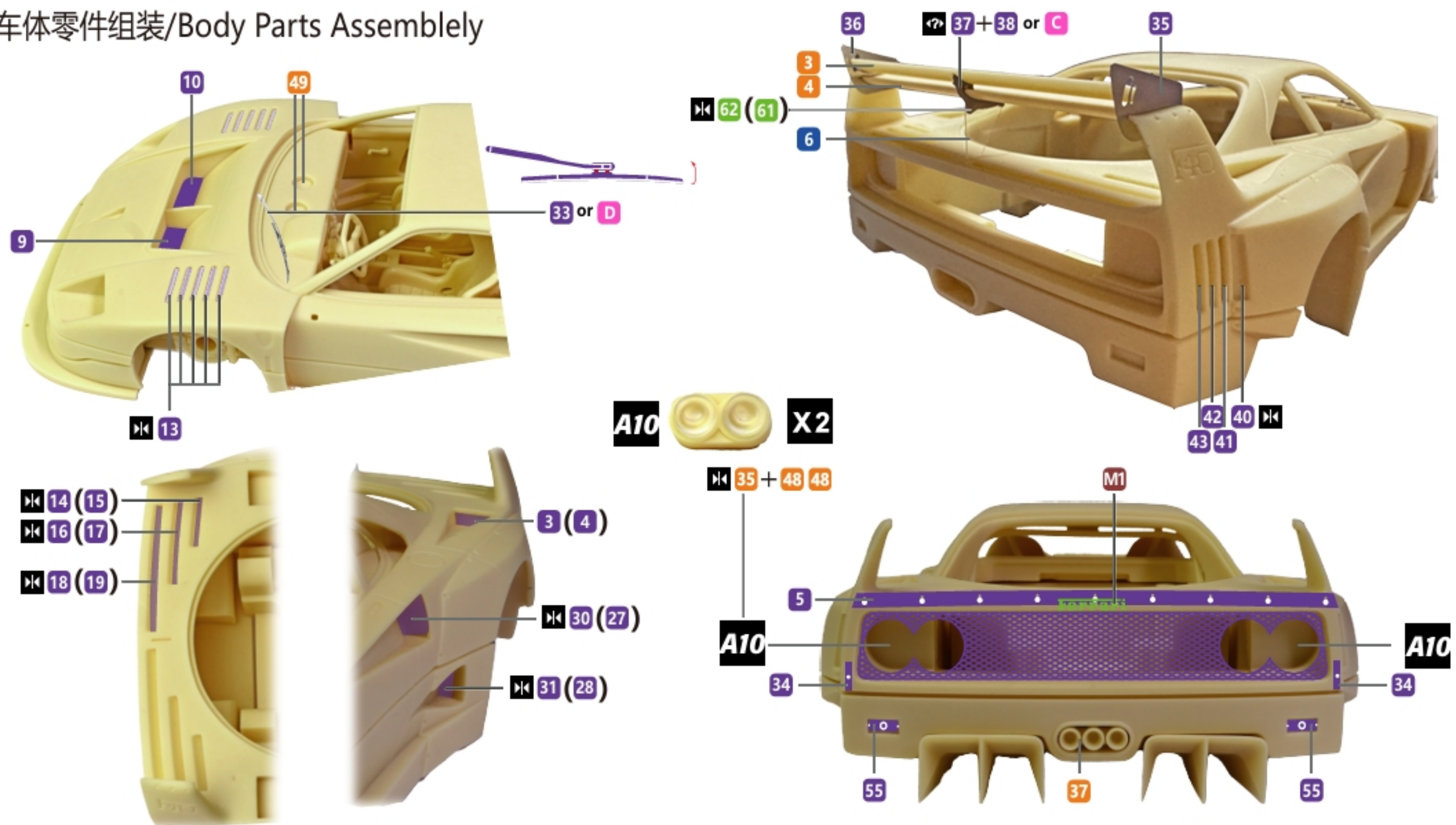

水贴指示/Markings Instruction

A 东京改装展2024展车涂装 / 'TAS2024' Showcar Livery

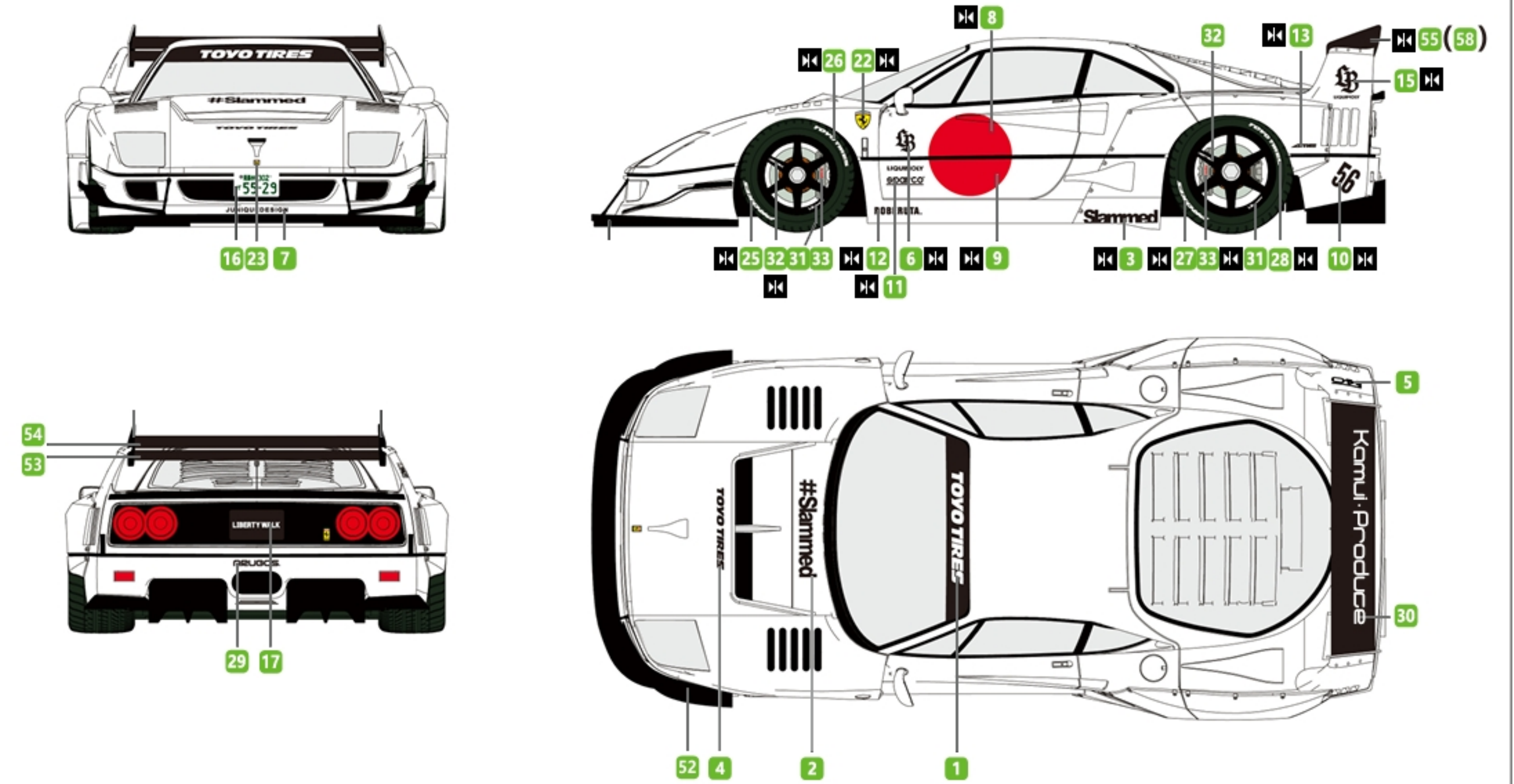

B '壳牌' 概念涂装 / 'Shell' Concept Livery

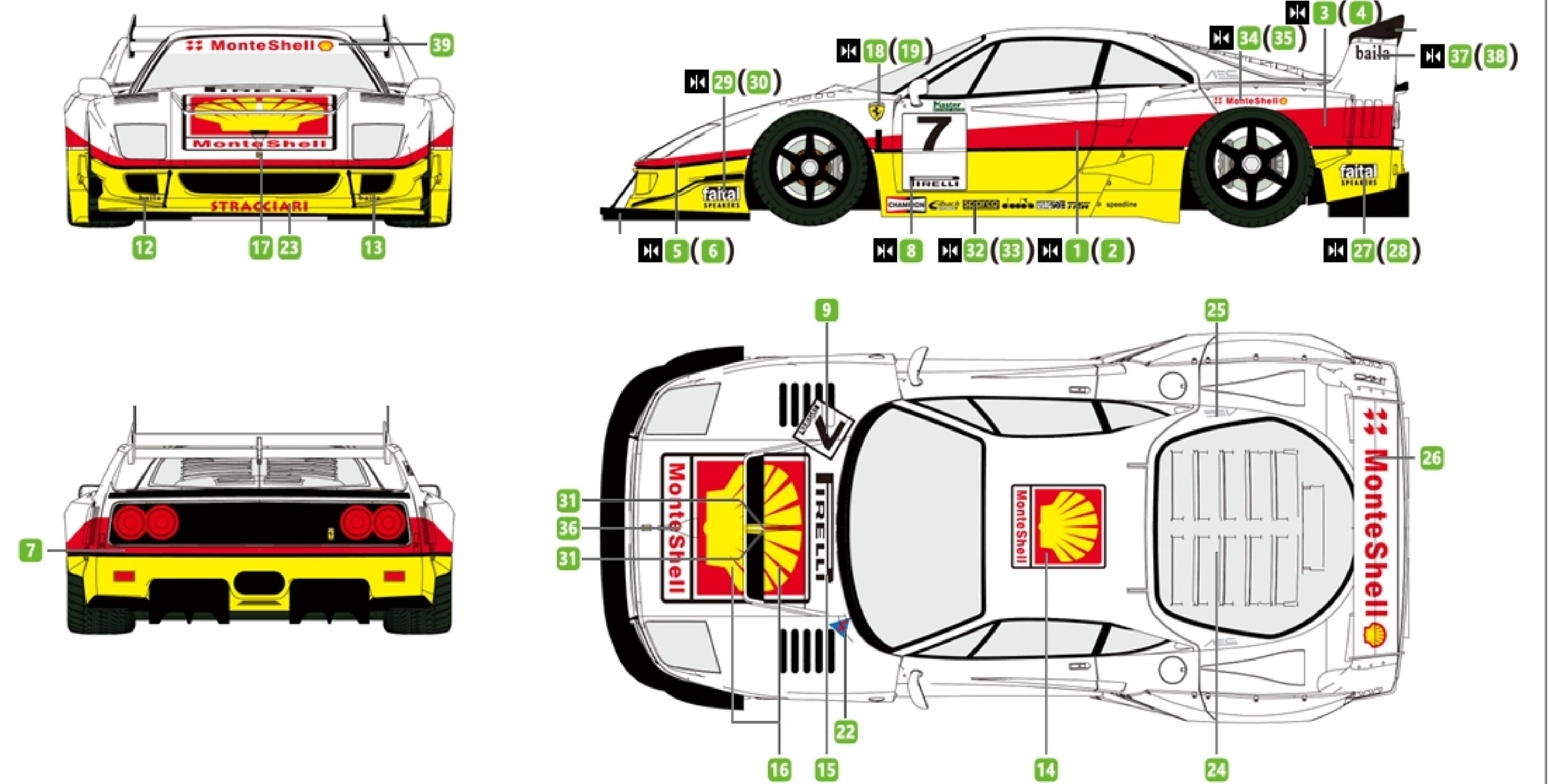

水贴指示/Markings Instruction

C '百乐' 涂装 / 'PILOT' Livery

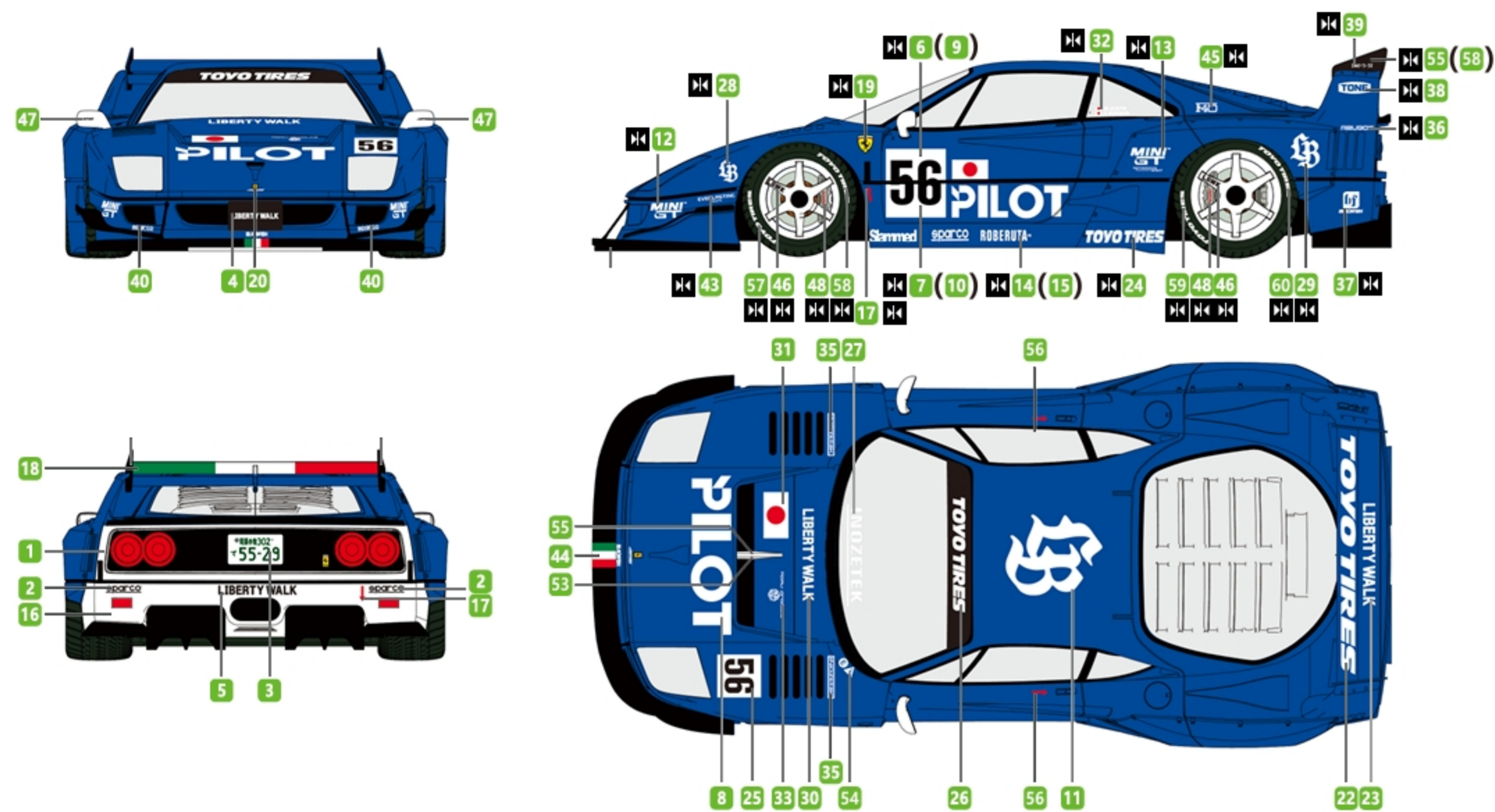

水贴指示/Markings Instruction

E '战斗灰' 概念涂装 / 'Combat Fighter' Concept Livery

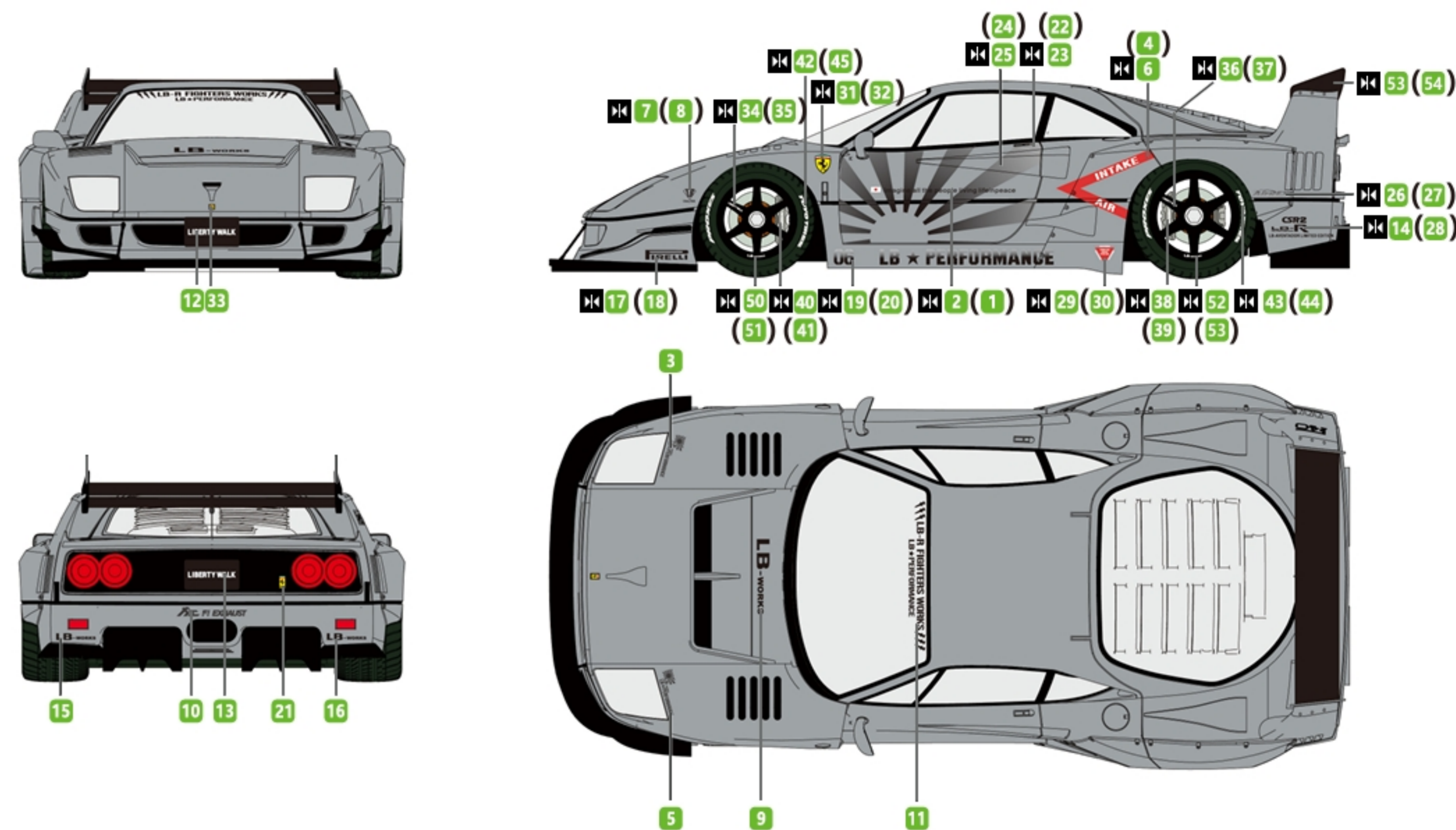

D '海湾石油' 概念涂装 / 'Gulf Oil' Concept Livery

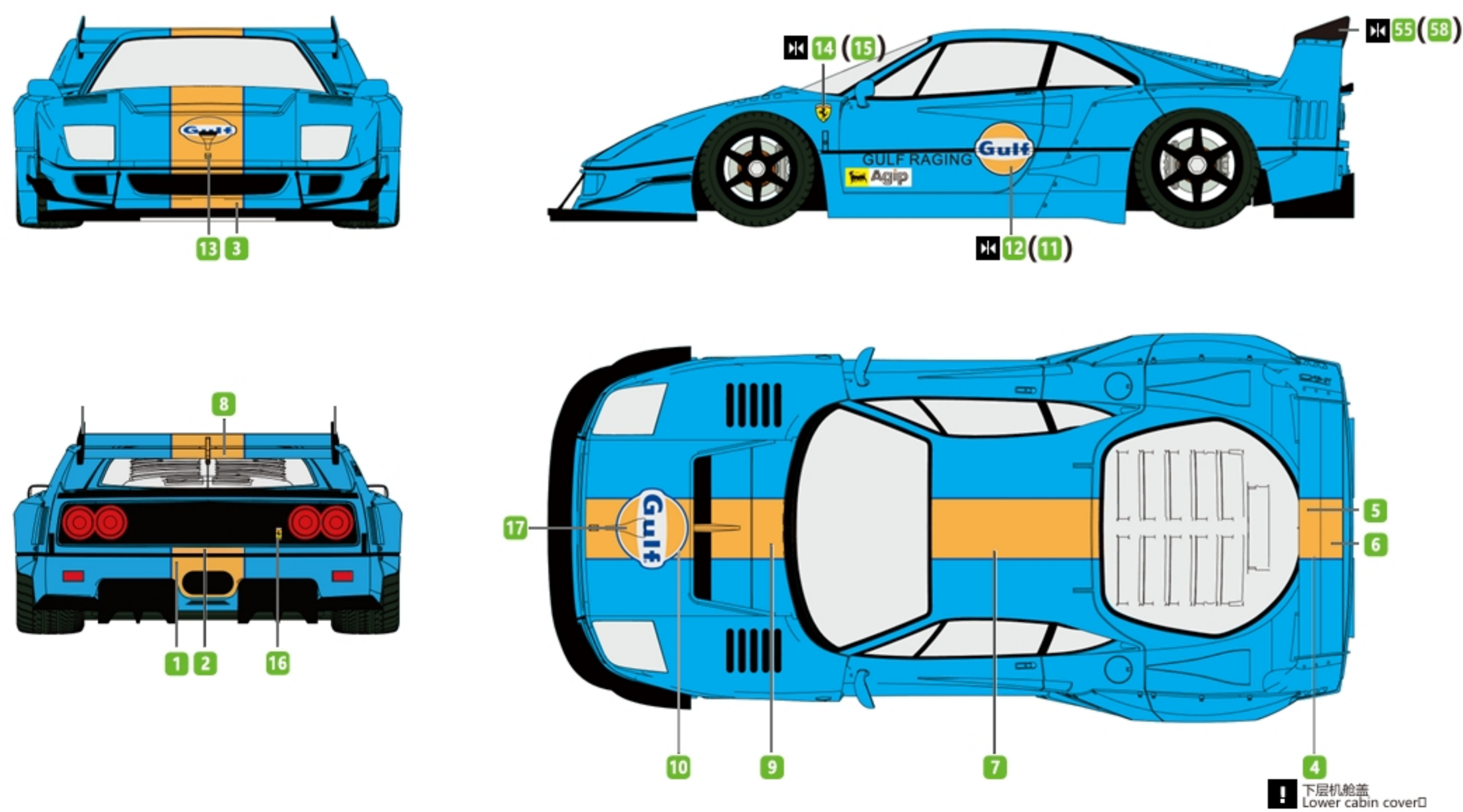

F '零战绿' 概念涂装 / 'Zero Fighter' Concept Livery

